



# LC75853NE, 75853NW

## 1/3 Duty LCD Display Drivers with Key Input Function



### Overview

The LC75853NE and LC75853NW are 1/3 duty LCD display drivers that can directly drive up to 126 segments and can control up to four general-purpose output ports. These products also incorporate a key scan circuit that accepts input from up to 30 keys to reduce printed circuit board wiring.

### Features

- Key input function for up to 30 keys (A key scan is performed only when a key is pressed.)
- 1/3 duty - 1/2 bias and 1/3 duty - 1/3 bias drive schemes can be controlled from serial data (up to 126 segments).
- Sleep mode and all segments off functions that are controlled from serial data
- Segment output port/general-purpose output port function switching that is controlled from serial data
- Serial data I/O supports CCB format communication with the system controller.
- Direct display of display data without the use of a decoder provides high generality.
- Provision of an on-chip voltage-detecting system reset circuit prevents incorrect displays.
- RC oscillator circuit

- CCB is a trademark of SANYO ELECTRIC CO., LTD.
- CCB is SANYO's original bus format and all the bus addresses are controlled by SANYO.

### Package Dimensions

unit: mm

#### 3159-QFP64E

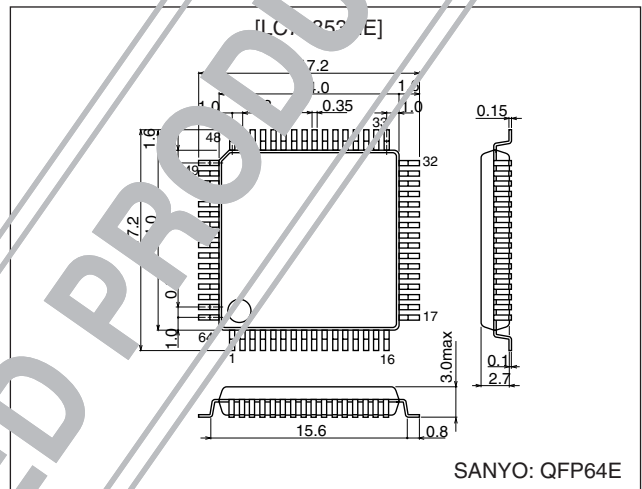

SANYO: QFP64E

unit: mm

#### 3150-SQFP64

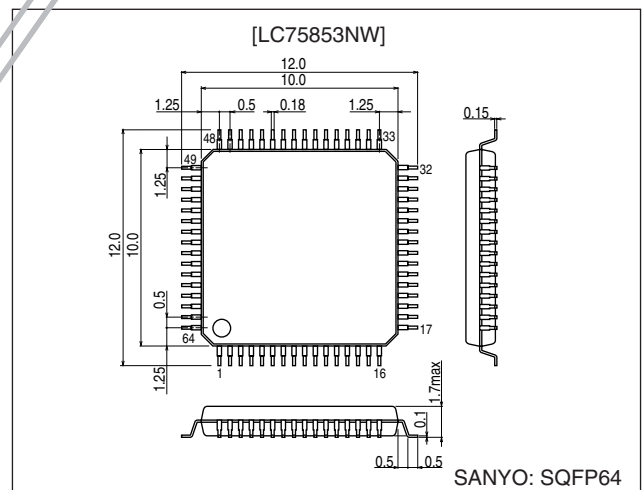

SANYO: SQFP64

■ Any of all SANYO products described or contained herein do not have specifications that can handle applications that require extremely high levels of reliability, such as life-support systems, aircraft's control systems, or other applications whose failure can be reasonably expected to result in serious physical and/or material damage. Consult with your SANYO representative nearest you before using any SANYO products described or contained herein in such applications.

■ SANYO assumes no responsibility for equipment failures that result from using products at values that exceed, even momentarily, rated values (such as maximum ratings, operating condition ranges, or other parameters) listed in products specifications of any and all SANYO products described or contained herein.

**SANYO Electric Co.,Ltd. Semiconductor Company**

TOKYO OFFICE Tokyo Bldg., 1-10, 1 Chome, Ueno, Taito-ku, TOKYO, 110-8534 JAPAN

## Specifications

### Absolute Maximum Ratings at $T_a = 25^\circ\text{C}$ , $V_{SS} = 0\text{ V}$

Parameter	Symbol	Conditions	Ratings	Unit
Maximum supply voltage	$V_{DD\text{ max}}$	$V_{DD}$	-0.3 to +7.0	V
Input voltage	$V_{IN1}$	CE, CL, DI	-0.3 to +7.0	V
	$V_{IN2}$	OSC, KI1 to KI5, TEST, $V_{DD1}$ , $V_{DD2}$	-0.3 to $V_{DD} + 0.3$	V
Output voltage	$V_{OUT1}$	DO	-0.3 to +7.0	V
	$V_{OUT2}$	OSC, S1 to S42, COM1 to COM3, KS1 to KS6, P1 to P4	-0.3 to $V_{DD} + 0.3$	V
Output current	$I_{OUT1}$	S1 to S42	300	$\mu\text{A}$
	$I_{OUT2}$	COM1 to COM3	5	mA
	$I_{OUT3}$	KS1 to KS6	1	mA
	$I_{OUT4}$	P1 to P4	5	mA
Allowable power dissipation	$P_{d\text{ max}}$	$T_a = 85^\circ\text{C}$	200	mW
Operating temperature	$T_{opr}$		-40 to +85	$^\circ\text{C}$
Storage temperature	$T_{stg}$		-55 to +125	$^\circ\text{C}$

### Allowable Operating Ranges at $T_a = -40$ to $+85^\circ\text{C}$ , $V_{SS} = 0\text{ V}$

Parameter	Symbol	Conditions	Ratings			Unit
			min	typ	max	
Supply voltage	$V_{DD}$	$V_{DD}$	4.5		6.0	V
Input voltage	$V_{DD1}$	$V_{DD1}$		$2/3 V_{DD}$	$V_{DD}$	V
	$V_{DD2}$	$V_{DD2}$		$1/3 V_{DD}$	$V_{DD}$	V
Input high level voltage	$V_{IH1}$	CE, CL, DI	$0.8 V_{DD}$		6.0	V
	$V_{IH2}$	KI1 to KI5	$0.6 V_{DD}$		$V_{DD}$	V
Input low level voltage	$V_{IL}$	CE, CL, DI, KI1 to KI5	0		$0.2 V_{DD}$	V
Recommended external resistance	$R_{OSC}$	OSC		68		$\text{k}\Omega$
Recommended external capacitance	$C_{OSC}$	OSC		820		pF
Guaranteed oscillation range	$f_{OSC}$	OSC	19	38	76	kHz
Data setup time	$t_{ds}$	CL, DI: Figure 2	160			ns
Data hold time	$t_{dh}$	CL, DI: Figure 2	160			ns
CE wait time	$t_{cp}$	CE, CL: Figure 2	160			ns
CE setup time	$t_{cs}$	CE, CL: Figure 2	160			ns
CE hold time	$t_{ch}$	CE, CL: Figure 2	160			ns
High level clock pulse width	$t_{oH}$	CE: Figure 2	160			ns
Low level clock pulse width	$t_{oL}$	CE: Figure 2	160			ns
Rise time	$t_r$	CE, CL, DI: Figure 2		160		ns
Fall time	$t_f$	CE, CL, DI: Figure 2		160		ns
DO output delay time	$t_{dO}$	DO, $R_{PU} = 4.7\text{ k}\Omega$ , $C_L = 10\text{ pF}^*1$ : Figure 2			1.5	$\mu\text{s}$
DO rise time	$t_{rO}$	DO, $R_{PU} = 4.7\text{ k}\Omega$ , $C_L = 10\text{ pF}^*1$ : Figure 2			1.5	$\mu\text{s}$

Note: \*1. Since DO is an open-drain output, these values depend on the resistance of the pull-up resistor  $R_{PU}$  and the load capacitance  $C_L$ .

Continued on next page.

Electrical Characteristics for the Allowable Operating Ranges

Parameter	Symbol	Conditions	Ratings			Unit
			min	typ	max	
Hysteresis	$V_H$	CE, CL, DI		$0.1 V_{DD}$		V
Power-down detection voltage	$V_{DET}$		2.7	3.0	3.3	V
Input high level current	$I_{IH}$	CE, CL, DI: $V_I = 6.0$ V			5.0	$\mu$ A
Input low level current	$I_{IL}$	CE, CL, DI: $V_I = 0$ V	-5.0			$\mu$ A
Input floating voltage	$V_{IF}$	KI1 to KI5			$0.05 V_{DD}$	V
Pull-down resistance	$R_{PD}$	KI1 to KI5: $V_{DD} = 5.0$ V	50	100	250	k $\Omega$
Output off leakage current	$I_{OFFH}$	DO: $V_O = 6.0$ V			6.0	$\mu$ A
Output high level voltage	$V_{OH1}$	KS1 to KS6: $I_O = -500$ $\mu$ A	$V_{DD} - 1.2$	$V_{DD} - 1.5$	$V_{DD} - 0.2$	V
	$V_{OH2}$	P1 to P4: $I_O = -1$ mA	$V_{DD} - 1.2$			V
	$V_{OH3}$	S1 to S42: $I_O = -20$ $\mu$ A	$V_{DD} - 1.0$			V
	$V_{OH4}$	COM1 to COM3: $I_O = -100$ $\mu$ A	$V_{DD} - 1.2$			V
Output low level voltage	$V_{OL1}$	KS1 to KS6: $I_O = 25$ $\mu$ A	2	0.5	1.5	V
	$V_{OL2}$	P1 to P4: $I_O = 1$ mA			1.0	V
	$V_{OL3}$	S1 to S42: $I_O = 20$ $\mu$ A			1.0	V
	$V_{OL4}$	COM1 to COM3: $I_O = 100$ $\mu$ A			1.0	V
	$V_{OL5}$	DO: $I_O = 1$ mA		0.1	0.5	V
Output middle level voltage*2	$V_{MID1}$	COM1 to COM3: 1/2 bias, $I_O = \pm 100$ $\mu$ A	$1/2 V_{DD} - 1.0$		$1/2 V_{DD} + 1.0$	V
	$V_{MID2}$	S1 to S42: 1/3 bias, $I_O = \pm 20$ $\mu$ A	$2/3 V_{DD} - 1.0$		$2/3 V_{DD} + 1.0$	V
	$V_{MID3}$	S1 to S42: 1/3 bias, $I_O = \pm 20$ $\mu$ A	$1/3 V_{DD} - 1.0$		$1/3 V_{DD} + 1.0$	V
	$V_{MID4}$	COM1 to COM3: 1/3 bias, $I_O = \pm 100$ $\mu$ A	$2/3 V_{DD} - 1.0$		$2/3 V_{DD} + 1.0$	V
	$V_{MID5}$	COM1 to COM3: 1/3 bias, $I_O = \pm 100$ $\mu$ A	$1/3 V_{DD} - 1.0$		$1/3 V_{DD} + 1.0$	V
Oscillator frequency	$f_{OSC}$	OSC/R = 68 k $\Omega$ , C = 220 pF	30.4	38	45.6	kHz
Current drain	$I_{DD1}$	Sleep mode			100	$\mu$ A
	$I_{DD2}$	$V_{DD} = 6.0$ V, output open, 1/2 bias, $f_{OSC} = 38$ kHz		350	700	$\mu$ A
	$I_{DD3}$	$V_{DD} = 6.0$ V, output open, 1/3 bias, $f_{OSC} = 38$ kHz		300	600	$\mu$ A

Note: \*2. Excluding the bias voltage generation divider resistors, split into  $V_{DD1}$  and  $V_{DD2}$ . (See Figure 1.)

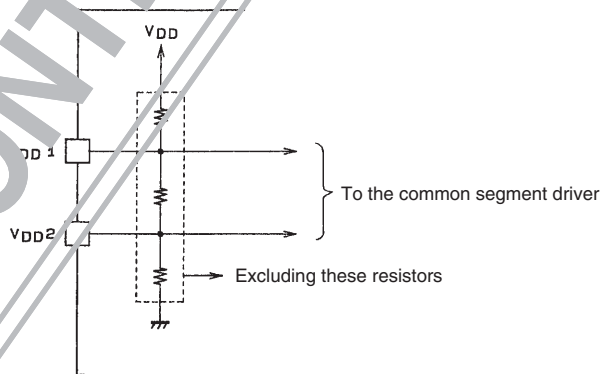

A03044

Figure 1

1. When CL is stopped at the low level

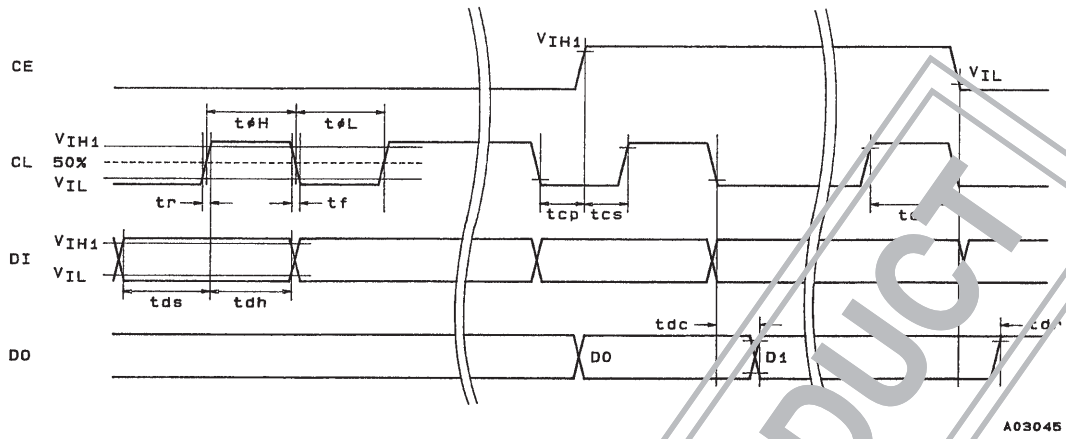

2. When CL is stopped at the high level

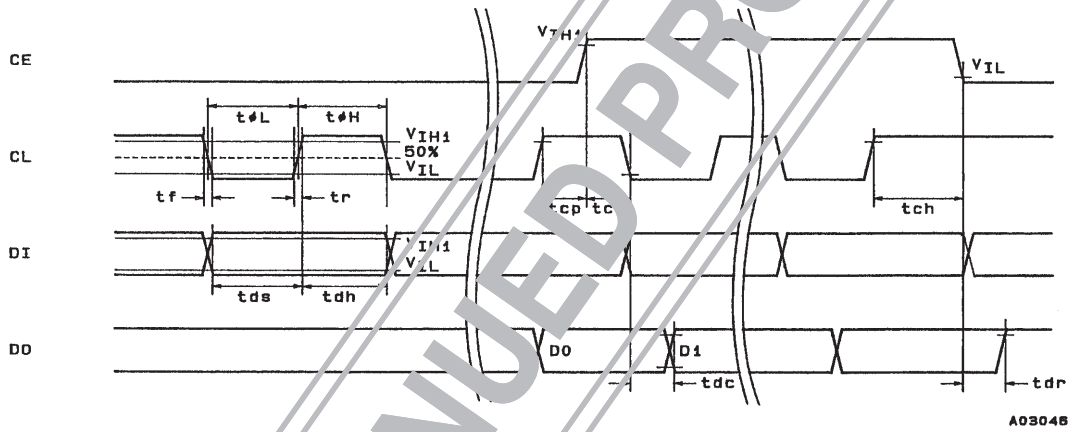
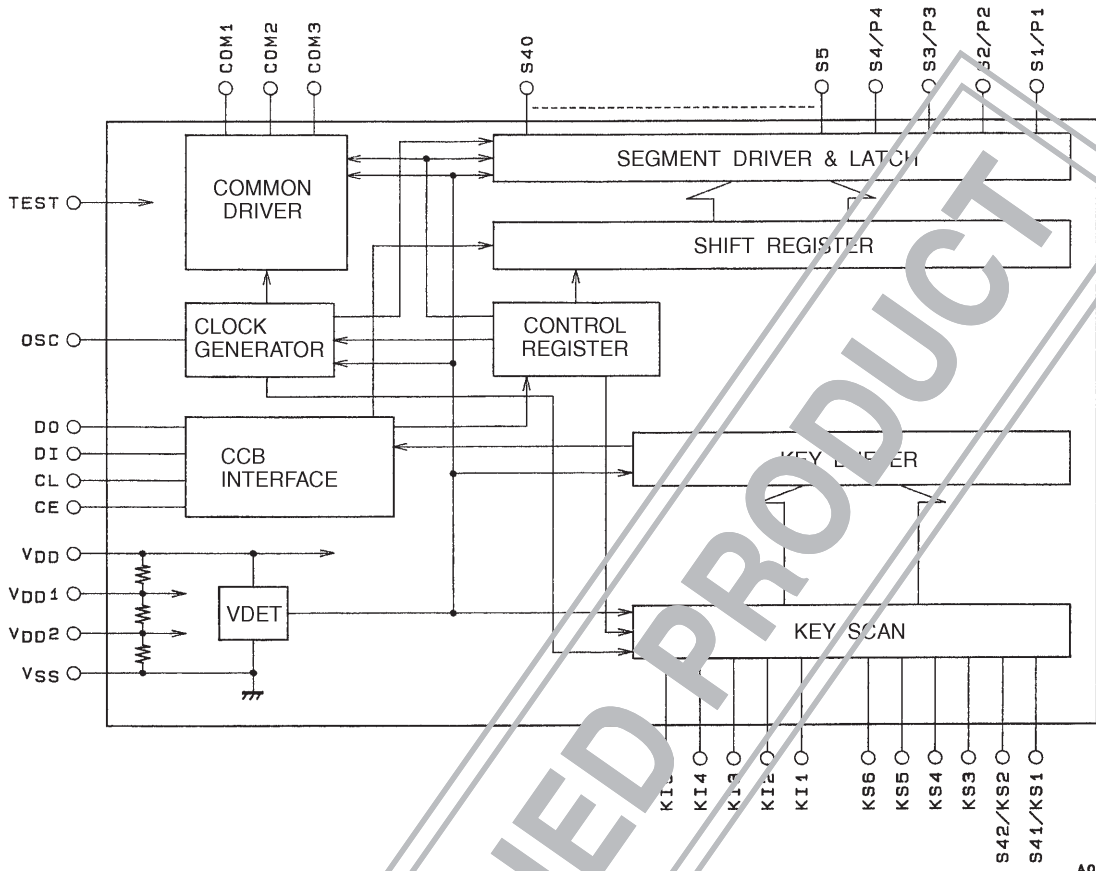

Figure 2

DISCONTINUED PRODUCT

Block Diagram



A03047

Pin Assignment

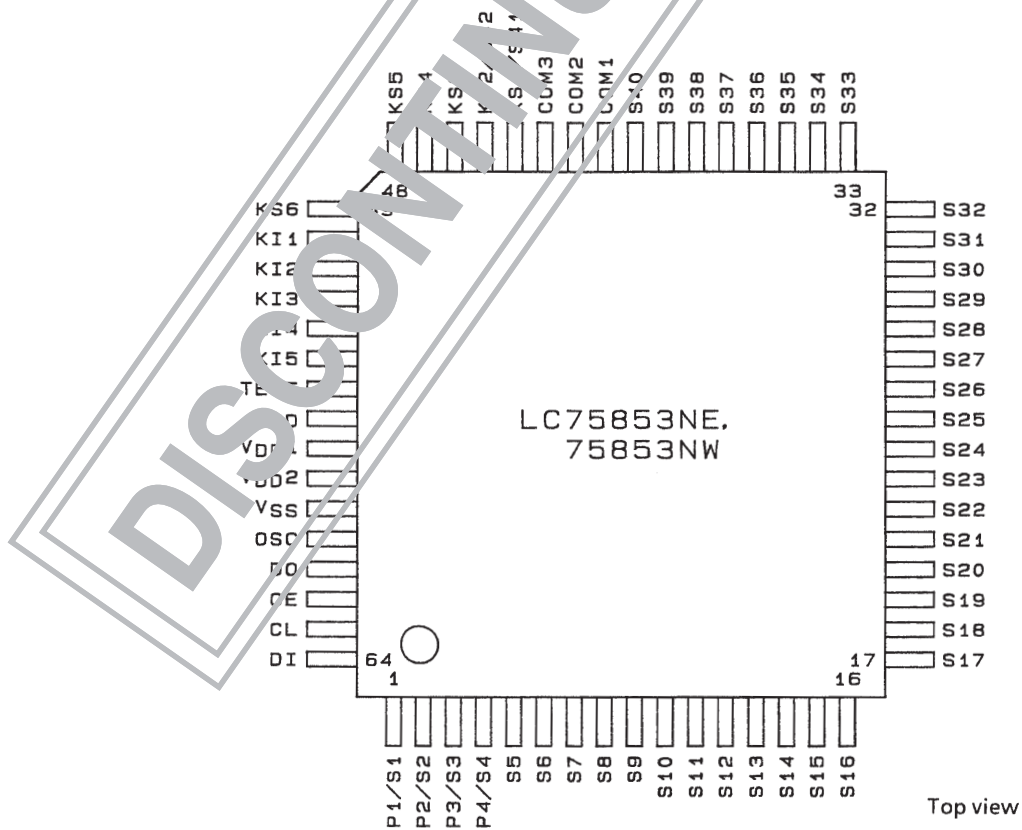

Top view

A03043

LC75853NE, 75853NW

Pin Functions

Pin	Pin No.	Function	Active	I/O	Handling when unused
S1/P1 to S4/P4 S5 to S40	1 to 4 5 to 40	Segment outputs for displaying the display data transferred by serial data input. The S1/P1 to S4/P4 pins can be used as general-purpose output ports under serial data control.	—	O	Open
COM1 COM2 COM3	41 42 43	Common driver outputs The frame frequency $f_O$ is given by: $f_O = (f_{OSC}/384)$ Hz.	—	O	Open
KS1/S41, KS2/S42, KS3 to KS6	44 45 46 to 49	Key scan outputs Although normal key scan timing lines require diodes to be inserted in the timing lines to prevent shorts, since these outputs are unbalanced CMC transistor outputs, these outputs will not be damaged by shorting when these outputs are used to form a key matrix. The KS1/S41 and KS2/S42 pins can be used as segment outputs when so specified by line control data.	—	O	Open
KI1 to KI5	50 to 54	Key scan inputs These pins have built-in pull-down resistors.	H	I	GND
OSC	60	Oscillator connection An oscillator circuit is formed by connecting an external resistor and capacitor at this pin.	—	I/O	V <sub>DD</sub>
CE CL DI DO	62 63 64 61	Serial data interface connections to the controller. Note that DO, being an open-drain output, requires a pull-up resistor. CE: Chip enable CL: Synchronization clock DI: Transfer data DO: Output data	H  — —	I I I O	GND  Open
TEST	55	This pin must be connected to ground.	—	I	—
V <sub>DD1</sub>	57	Used for applying the LCD drive 2/3 bias voltage externally. Must be connected to V <sub>DD</sub> when the 2/3 bias drive scheme is used.	—	I	Open
V <sub>DD2</sub>	58	Used for applying the LCD drive 1/3 bias voltage externally. Must be connected to V <sub>DD1</sub> when a 1/2 bias drive scheme is used.	—	I	Open
V <sub>DD</sub>	56	Power supply connection. Provide a voltage of between 4.5 and 6.0 V.	—	—	—
V <sub>SS</sub>	59	Power supply connection. Connect to ground.	—	—	—

DISCONTINUED PRODUCT

Serial Data Input

1. When CL is stopped at the low level

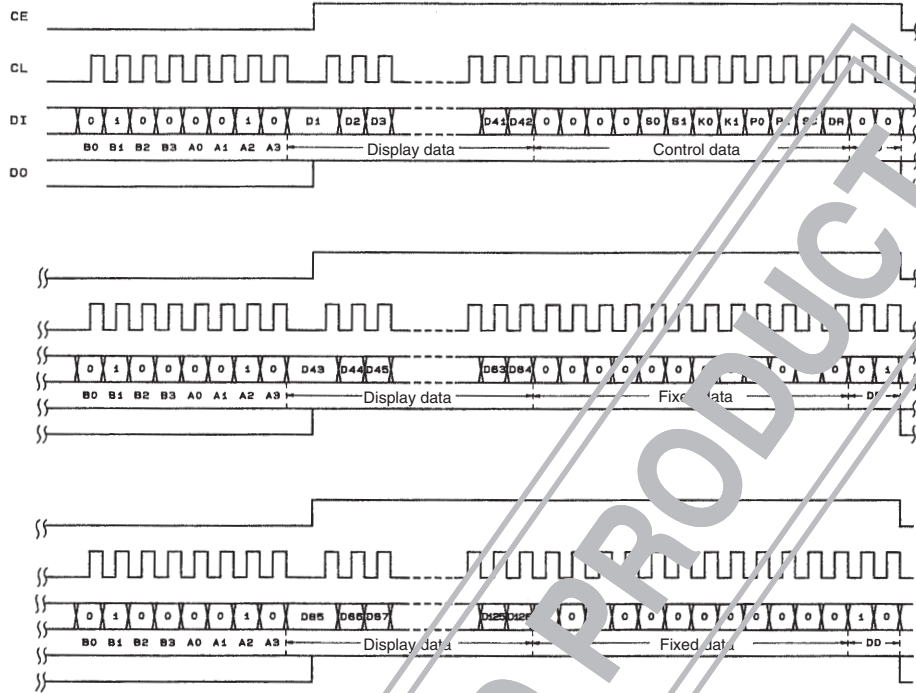

Note: DD: Direction data

2. When CL is stopped at the high level

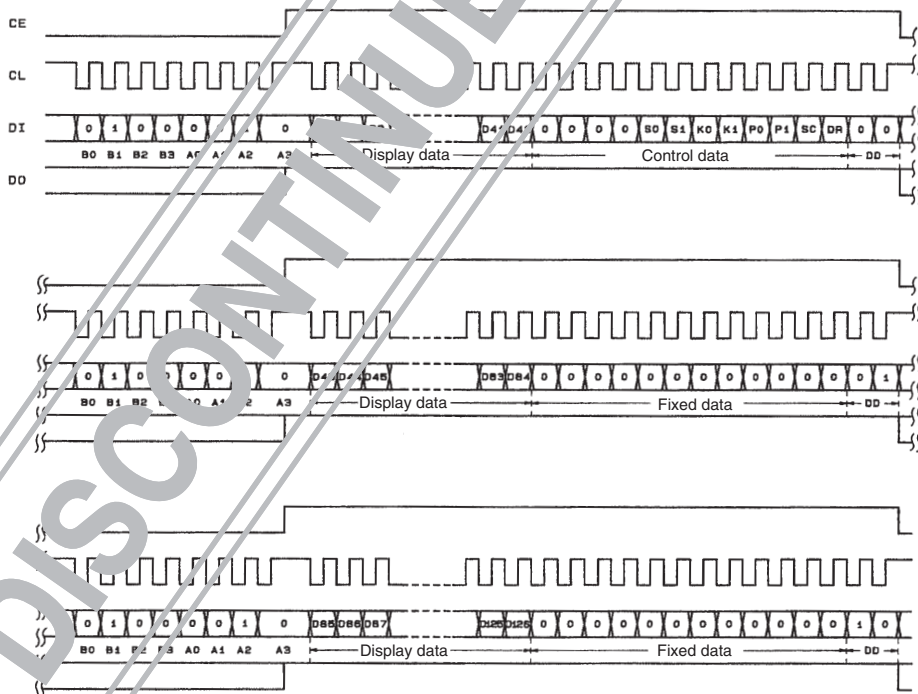

Note: DD: Direction data

- CCB address.....42H
- D1 to D126.....Display data
- S0, S1 .....Sleep control data
- K0, K1 .....Key scan output/segment output selection data
- P0, P1 .....Segment output port/general-purpose output port selection data
- SC.....Segment on/off control data
- DR .....1/2 bias or 1/3 bias drive selection data

**Control Data Functions**

1. S0, S1: Sleep control data

These control data bits switch between normal mode and sleep mode and set the states of the KS1 to KS6 key scan outputs during key scan standby.

Control data		Mode	OSC oscillator	Segment outputs Common outputs	Output pin states during key scan standby					
S0	S1				KS1	KS2	KS3	KS4	KS5	KS6
0	0	Normal	Operating	Operating	H	H	H	H	H	H
0	1	Sleep	Stopped	L	L	L	L	L	L	H
1	0	Sleep	Stopped	L	L	L	L	H	H	H
1	1	Sleep	Stopped	L	H	H	H	H	H	H

Note: This assumes that the KS1/S41 and KS2/S42 output pins are selected for key scan output.

2. K0, K1: Key scan output/segment output selection data

These control data bits switch the functions of the KS1/S41 and KS2/S42 output pins between key scan output and segment output.

Control data		Output pin state		Maximum number of input pins
K0	K1	KS1/S41	KS2/S42	
0	0	KS1	KS2	20
0	1	S41	KS2	25
1	X	S41	S42	20

X: don't care

3. P0, P1: Segment output port/general-purpose output port selection data

These control data bits switch the functions of the S1/P1 to S4/P4 output pins between the segment output port and the general-purpose output port.

Control data		Output pin state			
P0	P1	S1/P1	S2/P2	S3/P3	S4/P4
0	0	S1	S2	S3	S4
0	1	P1	P2	P3	S4
1	0	P1	P2	P3	S4
1	1	P1	P2	P3	P4

The table below lists the correspondence between the display data and the output pins when these pins are selected to be general-purpose output port.

Output pin	Corresponding display data
S1/P1	D0
S2/P2	D4
S3/P3	D7
S4/P4	D10

For example, if the S1/P1 output pin is selected to be a general-purpose output port, the S4/P4 output pin will output a high level when the display data D10 is 1.

4. SC: Segment on/off control data

This control data bit controls the on/off state of the segments.

SC	Display state
0	On
1	Off

However, note that when the segments are turned off by setting SC to 1, the segments are turned off by outputting segment off waveforms from the segment output pins.



5. DR: 1/2 bias or 1/3 bias drive selection data

This control data bit switches between LCD 1/2 bias or 1/3 bias drive.

DR	Drive scheme
0	1/3 bias drive
1	1/2 bias drive

Display Data and Output Pin Correspondence

Output pin	COM1	COM2	COM3	Output pin	COM1	COM2	COM3
S1/P1	D1	D2	D3	S22	D64	D65	D66
S2/P2	D4	D5	D6	S23	D67	D68	D69
S3/P3	D7	D8	D9	S24	D70	D71	D72
S4/P4	D10	D11	D12	S25	D73	D74	D75
S5	D13	D14	D15	S26	D76	D77	D78
S6	D16	D17	D18	S27	D79	D80	D81
S7	D19	D20	D21	S28	D82	D83	D84
S8	D22	D23	D24	S29	D85	D86	D87
S9	D25	D26	D27	S30	D88	D89	D90
S10	D28	D29	D30	S31	D91	D92	D93
S11	D31	D32	D33	S32	D94	D95	D96
S12	D34	D35	D36	S33	D97	D98	D99
S13	D37	D38	D39	S34	D100	D101	D102
S14	D40	D41	D42	S35	D103	D104	D105
S15	D43	D44	D45	S36	D106	D107	D108
S16	D46	D47	D48	S37	D109	D110	D111
S17	D49	D50	D51	S38	D112	D113	D114
S18	D52	D53	D54	S39	D115	D116	D117
S19	D55	D56	D57	S40	D118	D119	D120
S20	D58	D59	D60	KS1/S41	D121	D122	D123
S21	D61	D62	D63	KS2/S42	D124	D125	D126

For example, the table below lists the segment output states for the S11 output pin.

Display data			Output pin state
D31	D32	D33	S11
0	0	0	The LCD segments for COM1, COM2 and COM3 are off.
0	0	1	The LCD segment for COM3 is on.
0	1	0	The LCD segment for COM2 is on.
0	1	1	The LCD segments for COM2 and COM3 are on.
1	0	0	The LCD segment for COM1 is on.
1	0	1	The LCD segments for COM1 and COM3 are on.
1	1	0	The LCD segments for COM1 and COM2 are on.
1	1	1	The LCD segments for COM1, COM2 and COM3 are on.

**Serial Data Output**

1. When CL is stopped at the low level

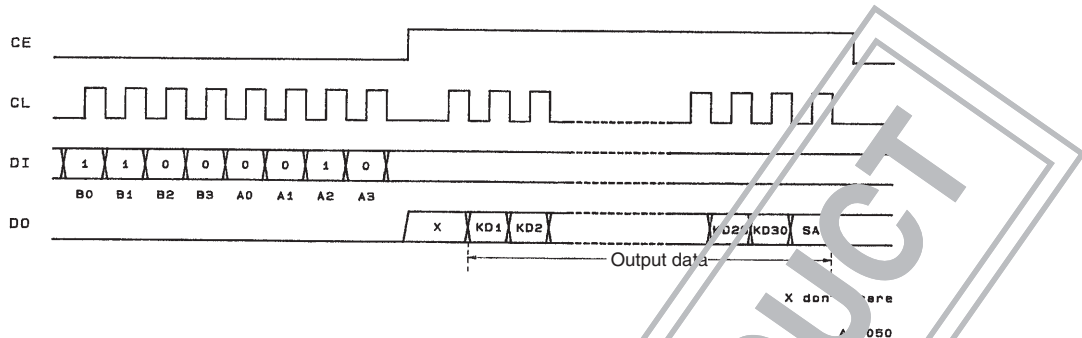

2. When CL is stopped at the high level

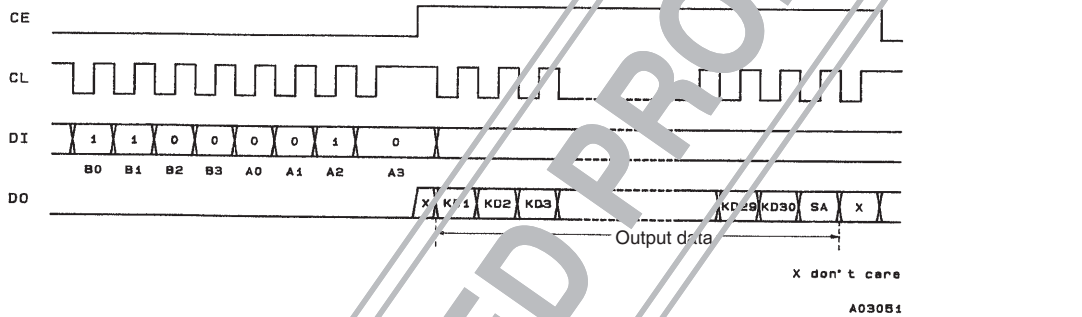

- CCB address.....43H
- KD1 to KD30.....Key data
- SA.....Sleep acknowledge data

Note: If a key data read operation is executed while DO is high, the read key data (KD1 to KD30) and sleep acknowledge data (SA) will be invalid.

**Output Data**

1. KD1 to KD30: Key data

When a key matrix of up to 30 keys is formed from the KS1 to KS6 output pins and the KI1 to KI5 input pins and one of those keys is pressed, the key output data corresponding to that key will be set to 1. The table shows the relationship between those pins and the key data bits.

	KI1	KI2	KI3	KI4	KI5
KS1/S41	KD1	KD2	KD3	KD4	KD5
KS2/S42	KD6	KD7	KD8	KD9	KD10
KS3	KD11	KD12	KD13	KD14	KD15
KS4	KD16	KD17	KD18	KD19	KD20
KS5	KD21	KD22	KD23	KD24	KD25
KS6	KD26	KD27	KD28	KD29	KD30

When the KS1/S41 and KS2/S42 output pins are selected to be segment outputs by control data bits K0 and K1 and a key matrix of up to 20 keys is formed using the KS3 to KS6 output pins and the KI1 to KI5 input pins, the KD1 to KD10 key data bits will be set to 0.

2. SA: Sleep acknowledge data

This output data bit is set to the state when the key was pressed. Also, while DO will be low in this case, if serial data is input and the mode is set (to normal or sleep mode) during this period, that mode will be set. SA will be 1 in sleep mode and 0 in normal mode.

## Sleep Mode Functions

Sleep mode is set up by setting S0 or S1 in the control data to 1. The segment outputs will all go low and the common outputs will also go low, and the oscillator on the OSC pin will stop (it will be started by a key press). This reduces power dissipation. This mode is cleared by sending control data with both S0 and S1 set to 0. However, note that the S1/P1 to S4/P4 outputs can be used as general-purpose output ports according to the state of the P0 and P1 control data bits, even in sleep mode. (See the control data description for details.)

## Key Scan Operation Functions

### 1. Key scan timing

The key scan period is  $288 T$  (s). To reliably determine the on/off state of the keys, the LC75853NE/NW scans the keys twice and determines that a key has been pressed when the key data agrees. It outputs a key data read request (a low level on DO)  $615 T$  (s) after starting a key scan. If the key data does not agree and a key was pressed at that point, it scans the keys again. Thus the LC75853NE/NW cannot detect a key press shorter than  $615 T$  (s).

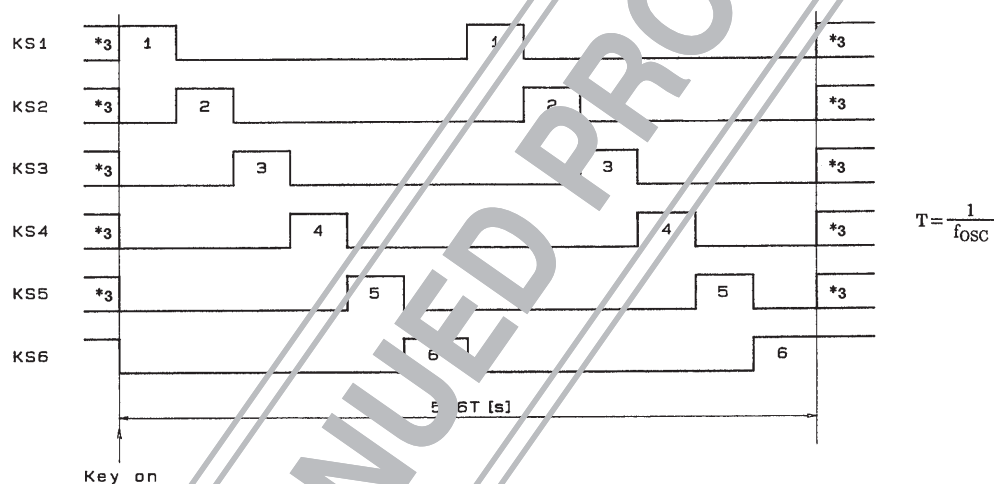

A03052

Note: \*3. In sleep mode the high/low state of these pins is determined by the S0 and S1 bits in the control data. Key scan output signals are not output from pins that are set low.

### 2. In normal mode

- The pins KS1 to KS6 are set high.
- When a key is pressed, key scan is started and the keys are scanned until all keys are released. Multiple key presses are recognized by determining whether multiple key data bits are set.
- If a key is pressed for longer than  $615 T$  (s) (where  $T = \frac{1}{f_{osc}}$ ) the LC75853NE/NW outputs a key data read request (a low level on DO) to the controller. The controller acknowledges this request and reads the key data. However, if CS is high during a serial data transfer, DO will be set high.
- After the controller reads the key data, the key data read request is cleared (DO is set high) and the LC75853NE/NW performs another key scan. Also note that DO, being an open-drain output, requires a pull-up resistor (between 1 and  $10 k\Omega$ ).

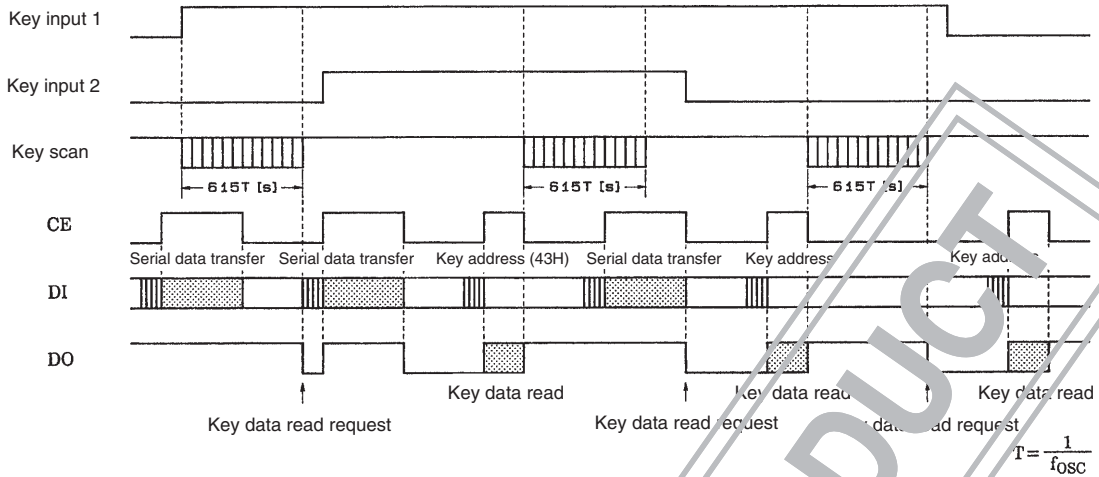

A03053

3. In sleep mode

- The pins KS1 to KS6 are set to high or low by the S0 and S1 bits of the control data. (See the control data description for details.)
- If a key on one of the lines corresponding to a KS1 to KS6 pin (which is set high) is pressed, the oscillator on the OSC pin is started and a key scan is performed. Keys are scanned until all keys are released. Multiple key presses are recognized by determining whether multiple key data bits are set.
- If a key is pressed for longer than 615 T (s) (where  $T = \frac{1}{f_{OSC}}$ ) the LC75853NE/NW outputs a key data read request (a low level on DO) to the controller. The controller acknowledges this request and reads the key data. However, if CE is high during a serial data transfer, DO will be set high.
- After the controller reads the key data, the key data read request is cleared (DO is set high) and the LC75853NE/NW performs another key scan. However, this does not clear sleep mode. Also note that DO, being an open-drain output, requires a pull-up resistor (between 1 and 10 kΩ).

• Sleep mode key scan example

Example: S0 = 0, S1 = 1 (sleep with only KS6 high)

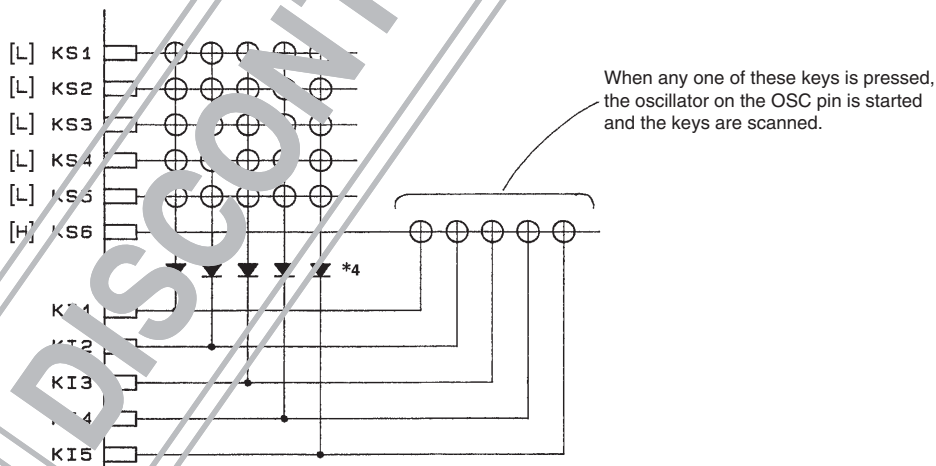

A03054

Note: \*4. These diodes are required to reliably recognize multiple key presses on the KS6 line when sleep mode state with only KS6 high, as in the above example. That is, these diodes prevent incorrect operations due to sneak currents in the KS6 key scan output signal when keys on the KS1 to KS5 lines are pressed at the same time.

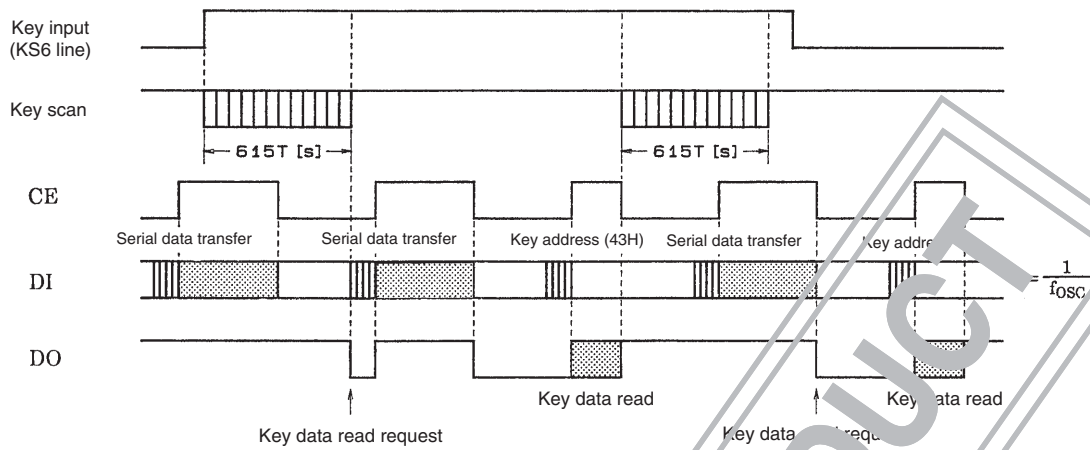

703055

### Multiple Key Presses

Although the LC75853NE/NW is capable of key scanning without including codes for dual key presses, triple key presses on the KI1 to KI5 input pin lines, or multiple key presses on the KS1 to KS6 output pin lines, multiple presses other than these cases may result in keys that were not pressed recognized as having been pressed. Therefore, a diode must be inserted in series with each key. Applications that do not recognize multiple key presses of three or more keys should check the key data for three or more 1 bits and ignore such data.

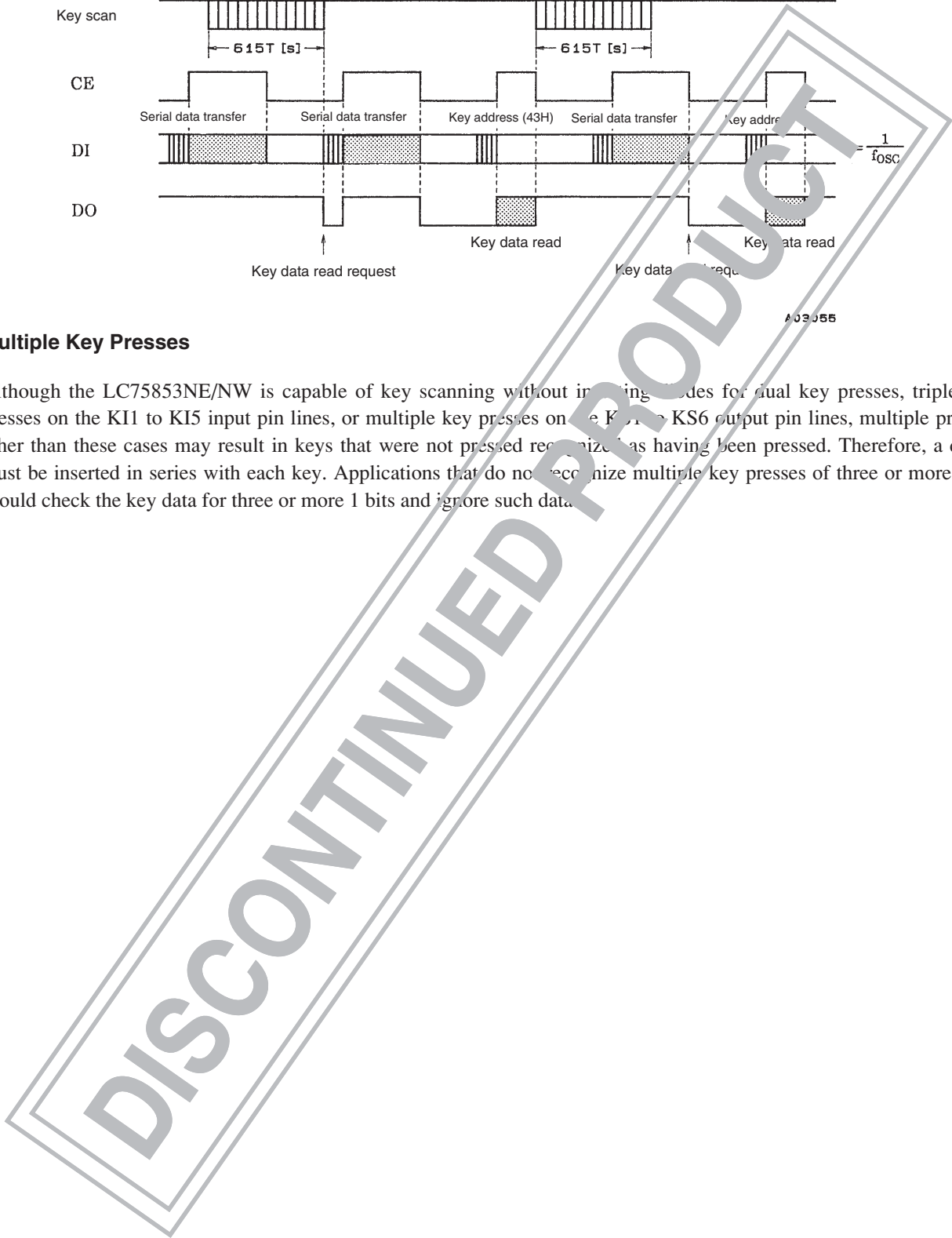

1/3 Duty, 1/2 Bias Drive Technique

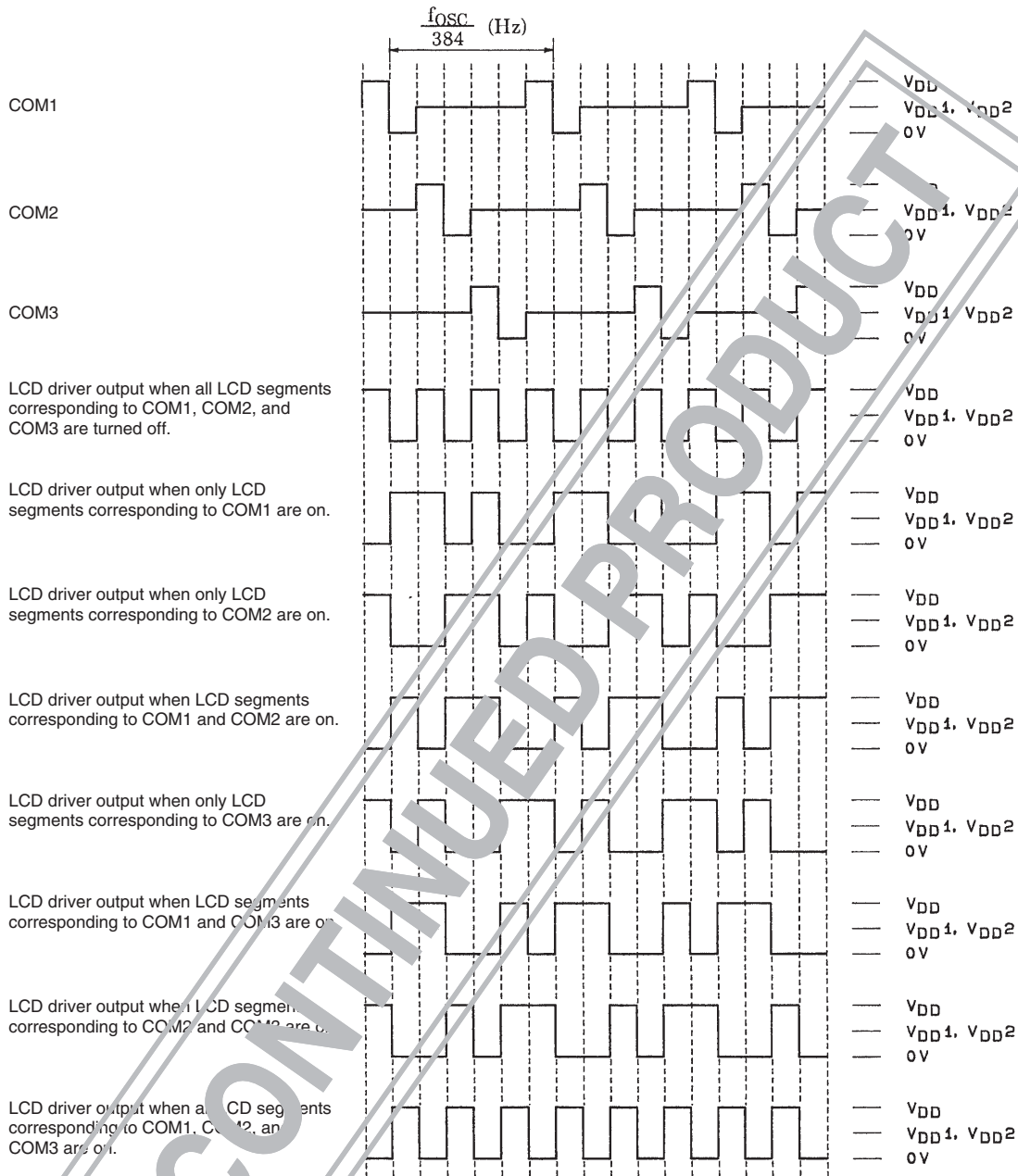

A03056

1/3 Duty, 1/2 Bias Waveforms

DISCONTINUED PRODUCT

1/3 Duty, 1/3 Bias Drive Technique

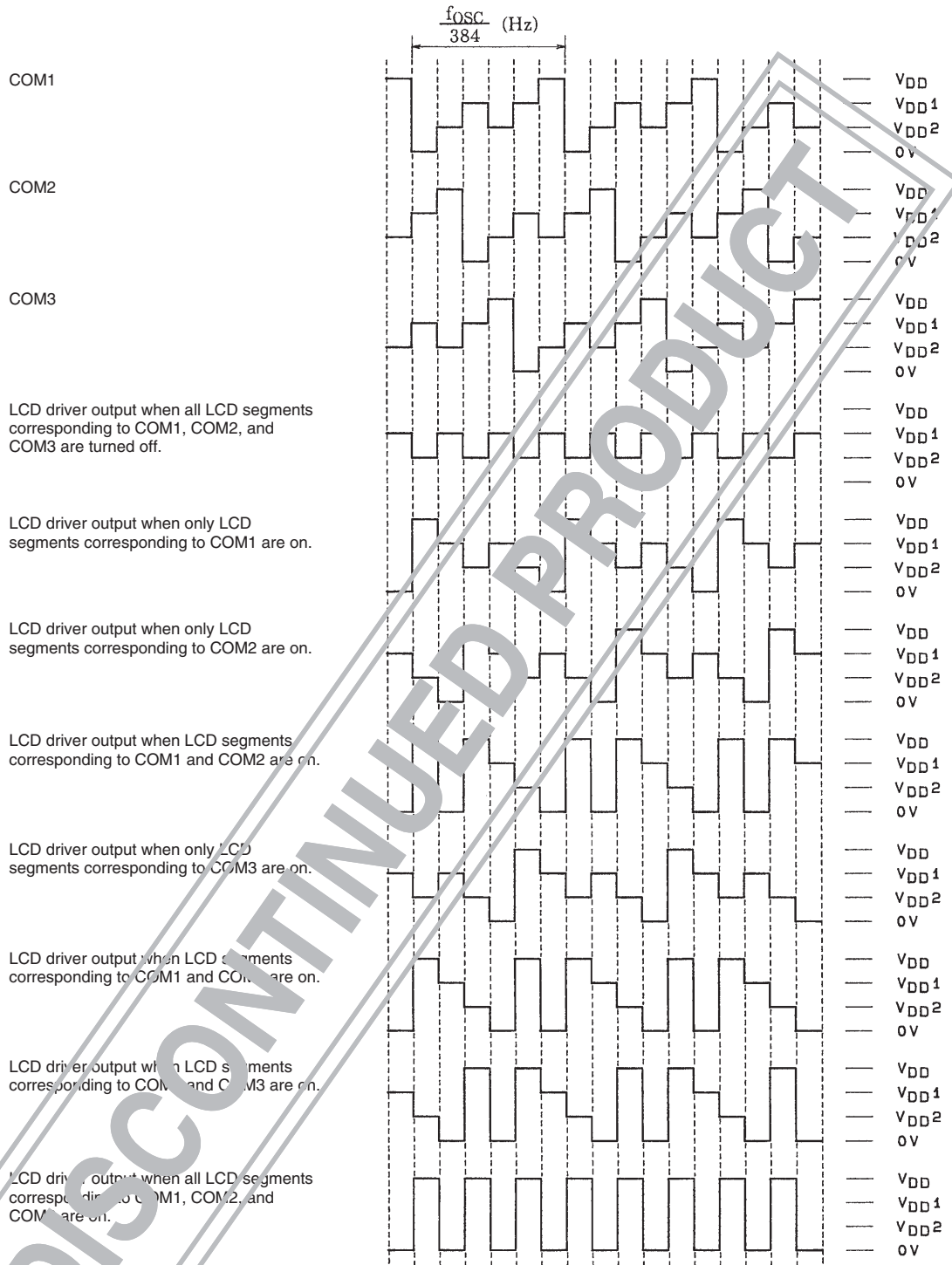

A03057

1/3 Duty, 1/3 Bias Waveforms

## Voltage Detection Type Reset Circuit (VDET)

This circuit generates an output signal and resets the system when power is first applied and when the voltage drops, i.e., when the power supply voltage is less than or equal to the power down detection voltage VDET, which is 3.0 V, typical. To assure that this function operates reliably, a capacitor must be added to the power supply line so that the power supply voltage  $V_{DD}$  rise time when power is first applied and the power supply voltage  $V_{DD}$  fall time when the voltage drops are both at least 1 ms. (See Figure 3.)

### System Reset

#### 1. Reset method

If at least 1 ms is assured as the supply voltage  $V_{DD}$  rise time when power is applied, a system reset will be applied by the VDET output signal when the supply voltage is brought up. If at least 1 ms is assured as the supply voltage  $V_{DD}$  fall time when power drops, a system reset will be applied in the same manner by the VDET output signal when the supply voltage is lowered. Note that the reset is cleared at the point when all the serial data (the display data D1 to D16 and the control data) has been transferred, i.e., on the fall of the CE signal or the transfer of the last direction data, after all the direction data has been transferred. (See Figure 3.)

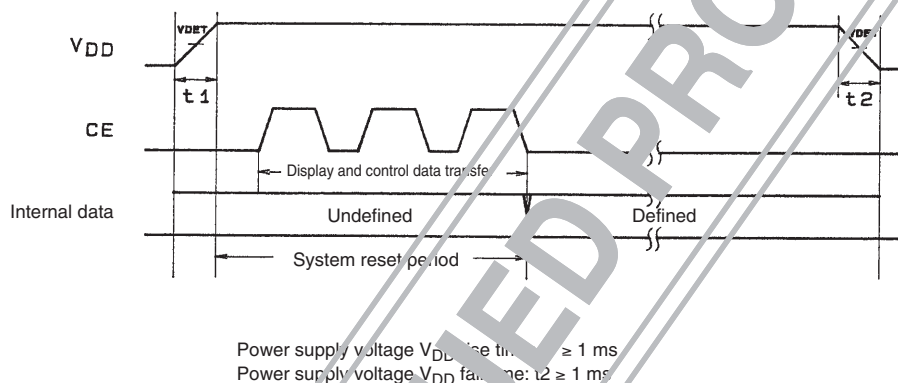

Figure 3

A03058

#### 2. LC75853NE/NW internal block states during the reset period

- **CLOCK GENERATOR**  
Reset is applied and the base clock is stopped. However the OSC pin state (normal or sleep mode) is determined after the S0 and S1 control data bits are transferred.
- **COMMON DRIVER, SEGMENT DRIVER & LATCH**  
Reset is applied and the display is turned off. However, display data can be input to the latch circuit in this state.
- **KEY SCAN**  
Reset is applied, the circuit is set to the initial state, and at the same time the key scan operation is disabled.
- **KEY BUFFER**  
Reset is applied and all the key data is set to low.
- **CCB INTERFACE, CONTROL REGISTER, SHIFT REGISTER**  
Since serial data transfer is possible, these circuits are not reset.



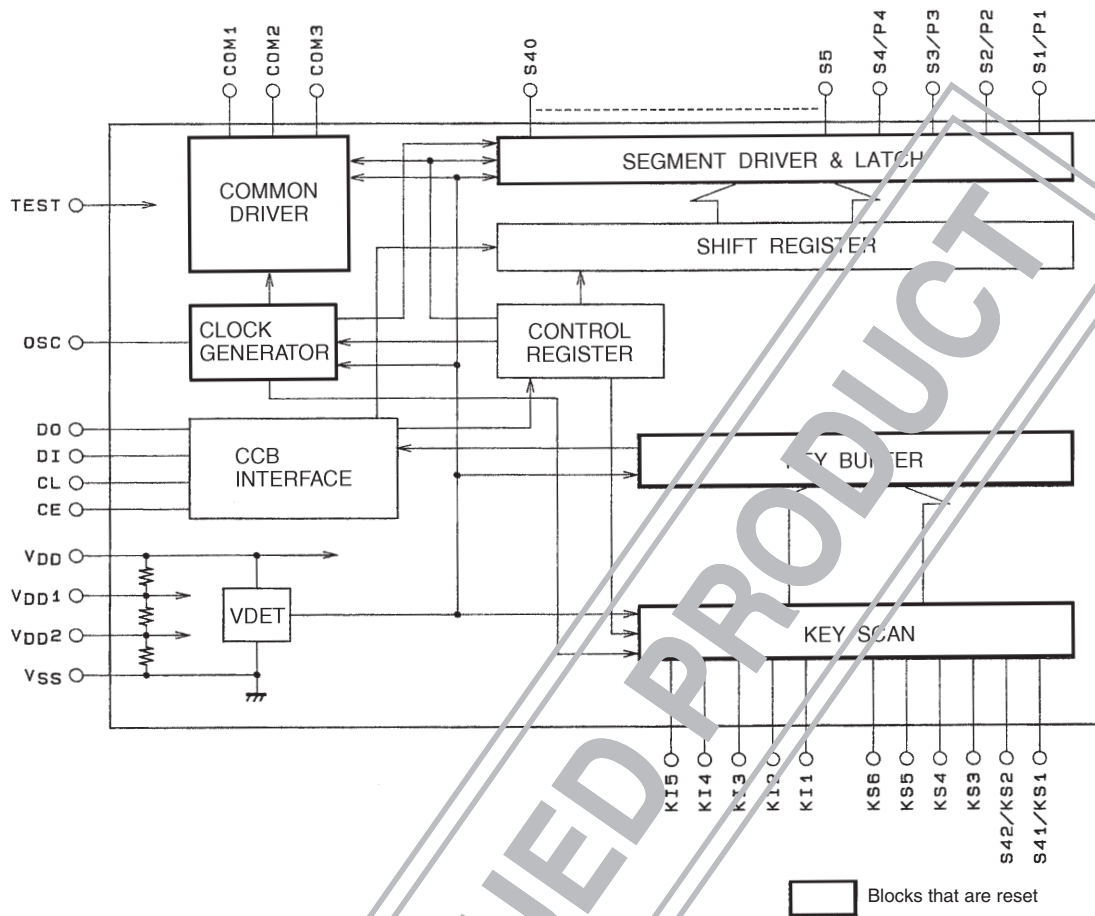

A03059

3. Output pin states during the reset period

Output pin	State during reset
S1/P1 to S4/P4	L <sup>5</sup>
S5 to S40	L <sup>5</sup>
COM1 to COM3	L
KS1/S41, KS2/S42	L <sup>6</sup>
KS3 to KS5	X <sup>*</sup>
KS6	H
DO	H <sup>*7</sup>

X: Don't care

Note: \*5/ These output pins are forcibly set to the segment output function and held low.

\*6. When power is first applied, these output pins are undefined until the S0 and S1 control data bits have been transferred.

\*7. Since this output is an open-drain output, a pull-up resistor of between 1 and 10 kΩ is required. This pin remains high during the reset period when the key data read operation is performed.

Sample Application Circuit 1

1/2 bias (for use with normal panels)

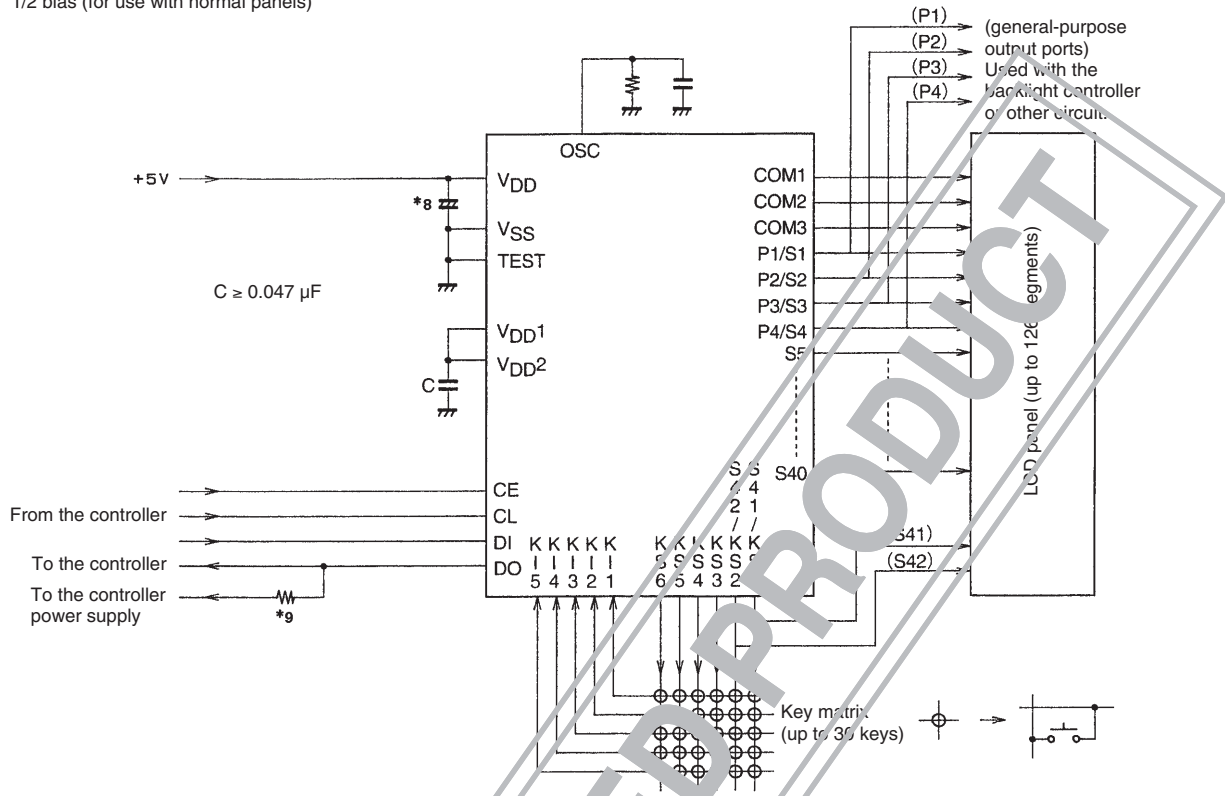

A04736

- Note: \*8. Add a capacitor to the power supply line so that the power supply voltage  $V_{DD}$  rise time when power is applied and the power supply voltage  $V_{DD}$  fall time when power drops are both at least 1 ms, as the LC75853NE/NW is reset by the VDET.
- \*9. The DO pin, being an open-drain output, requires a pull-up resistor. Select a resistance (between 1 to 10 k $\Omega$ ) appropriate for the capacitance of the external wiring so that signal waveforms are not degraded.

DISCONTINUED PRODUCT

Sample Application Circuit 2

1/2 bias (for use with large panels)

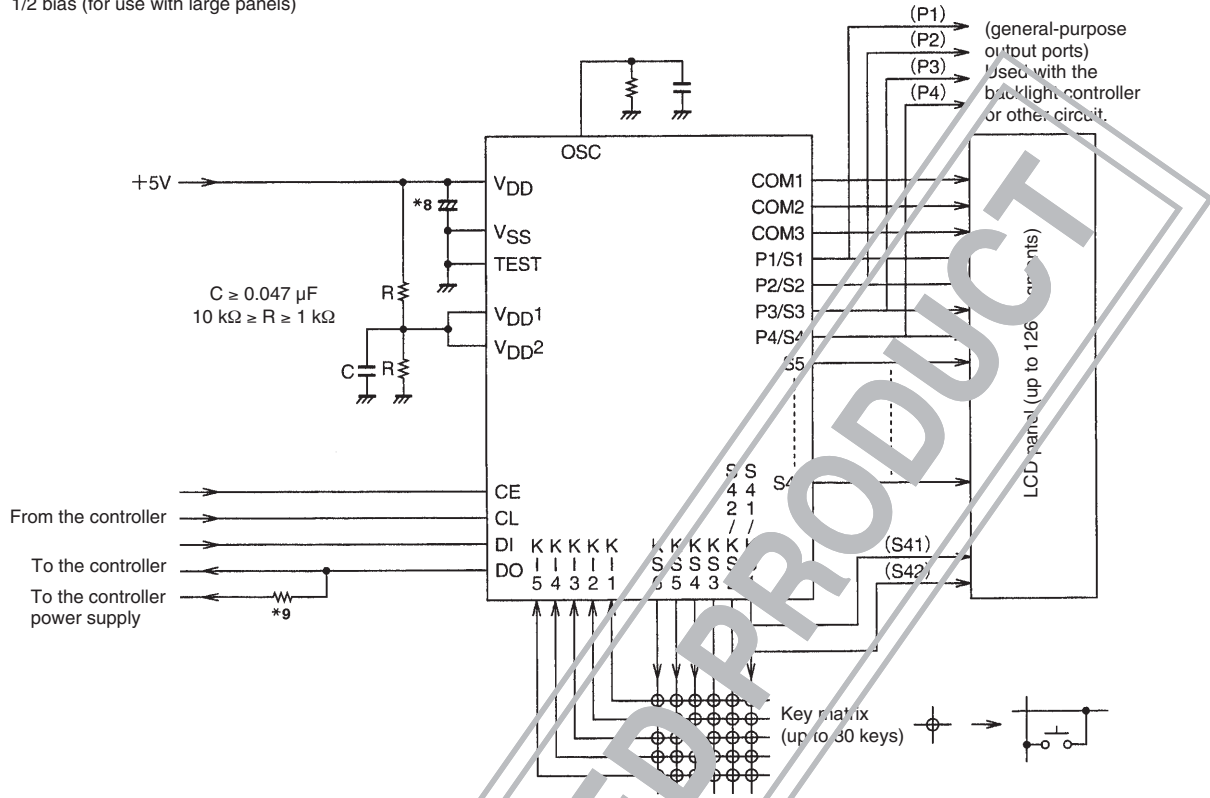

A11100

Note: \*8. Add a capacitor to the power supply line so that the power supply voltage  $V_{DD}$  rise time when power is applied and the power supply voltage  $V_{DD}$  fall time when power drops are both at least 1 ms, as the LC75853NE/NW is reset by the VDET.  
 \*9. The DO pin, being an open-drain output, requires a pull-up resistor. Select a resistance (between 1 to 10 k $\Omega$ ) appropriate for the capacitance of the external wiring so that signal waveforms are not degraded.

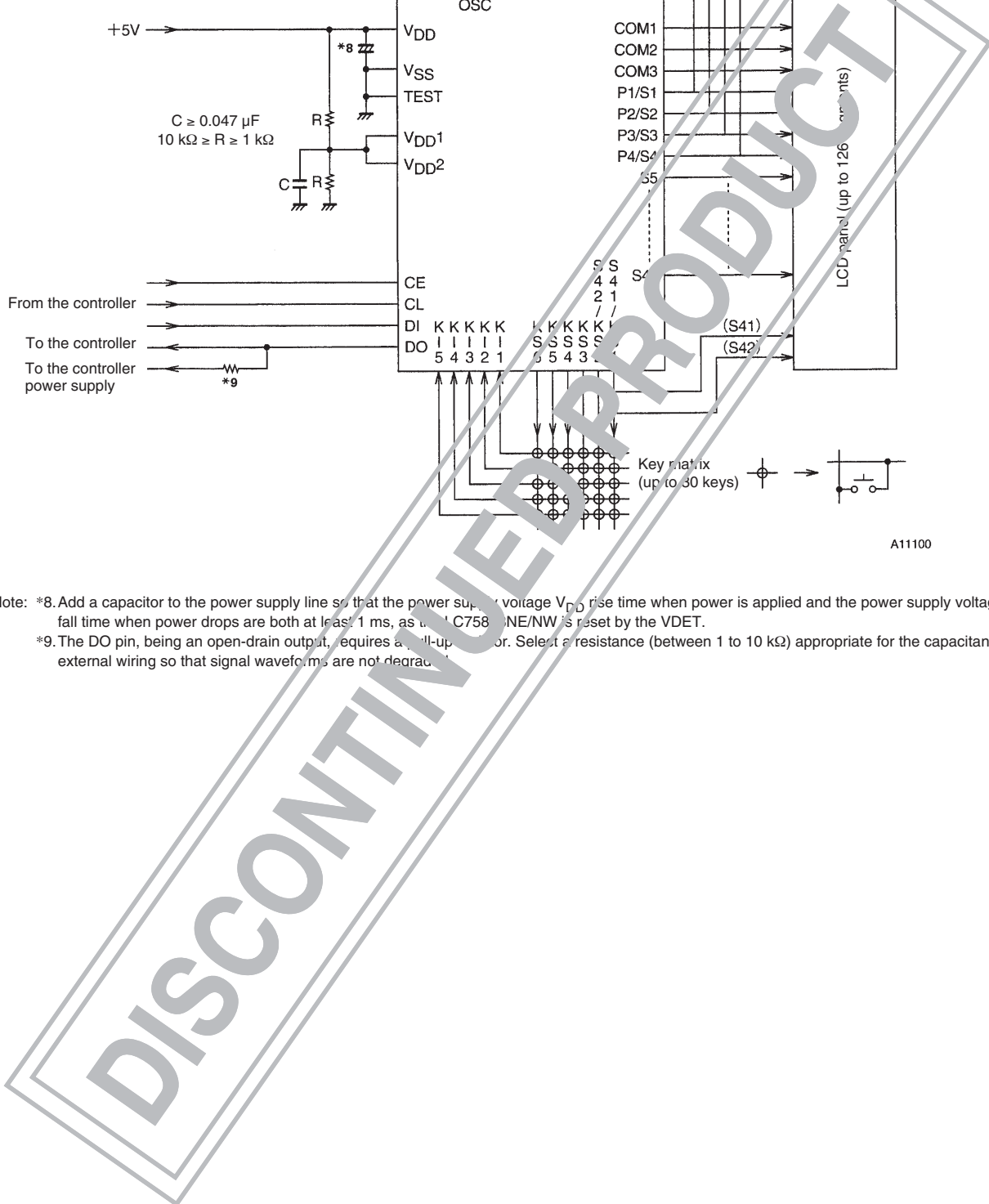

Sample Application Circuit 3

1/3 bias (for use with normal panels)

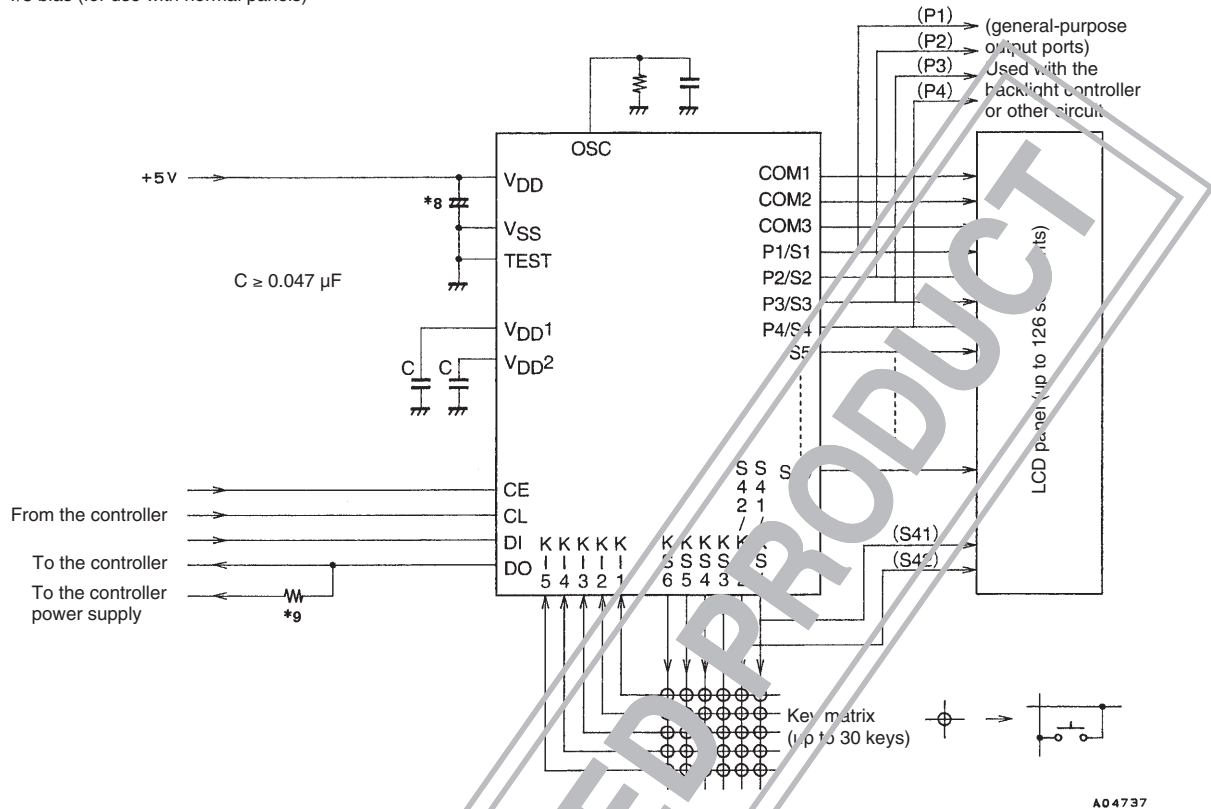

A04737

- Note: \*8. Add a capacitor to the power supply line so that the power supply voltage  $V_{DD}$  rise time when power is applied and the power supply voltage  $V_{DD}$  fall time when power drops are both at least 1 ms, as the LC75853NE/NW is reset by the VDET.
- \*9. The DO pin, being an open-drain output, requires a pull-up resistor. Select a resistance (between 1 to 10 k $\Omega$ ) appropriate for the capacitance of the external wiring so that signal waveforms are not degraded.

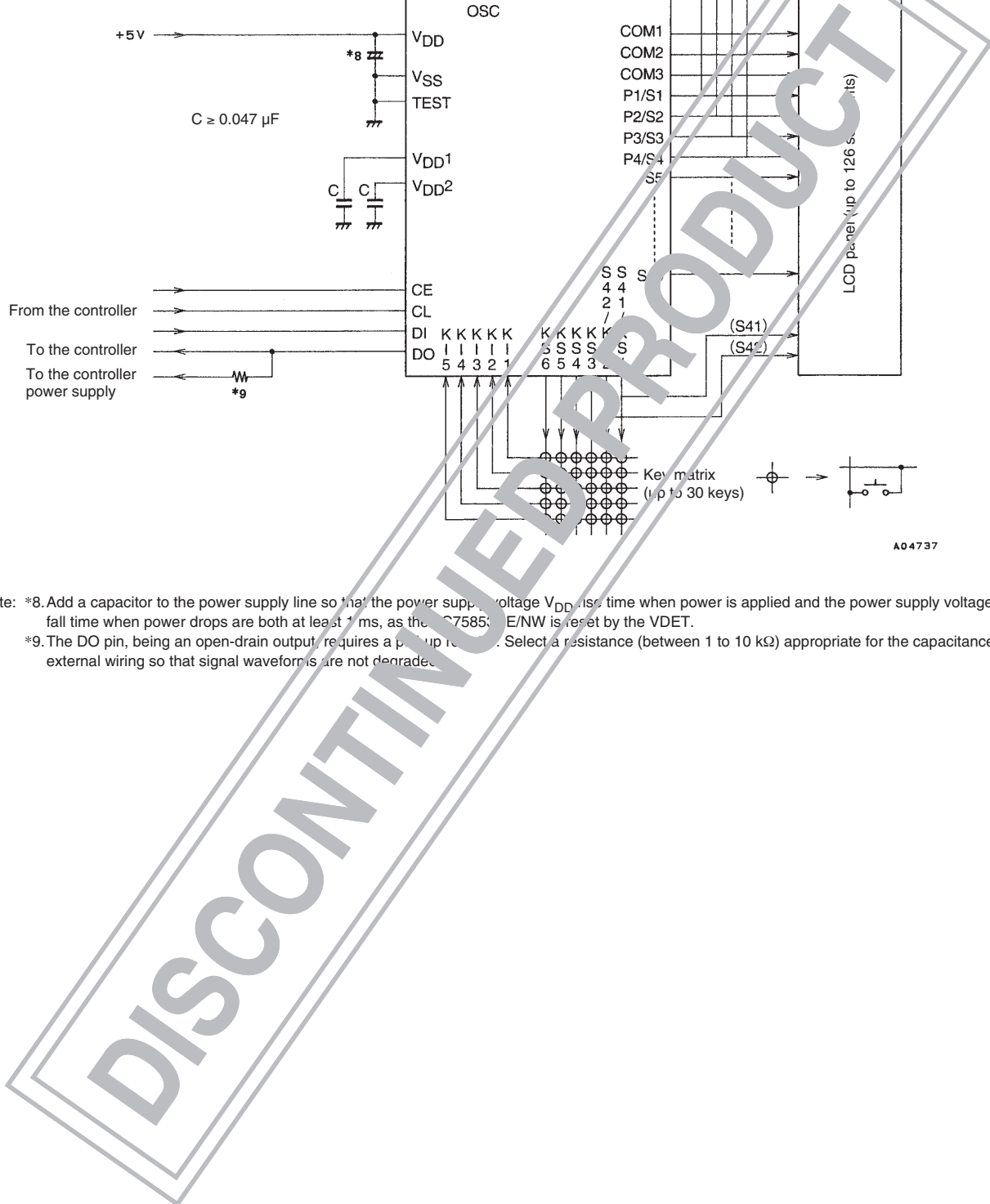

Sample Application Circuit 4

1/3 bias (for use with large panels)

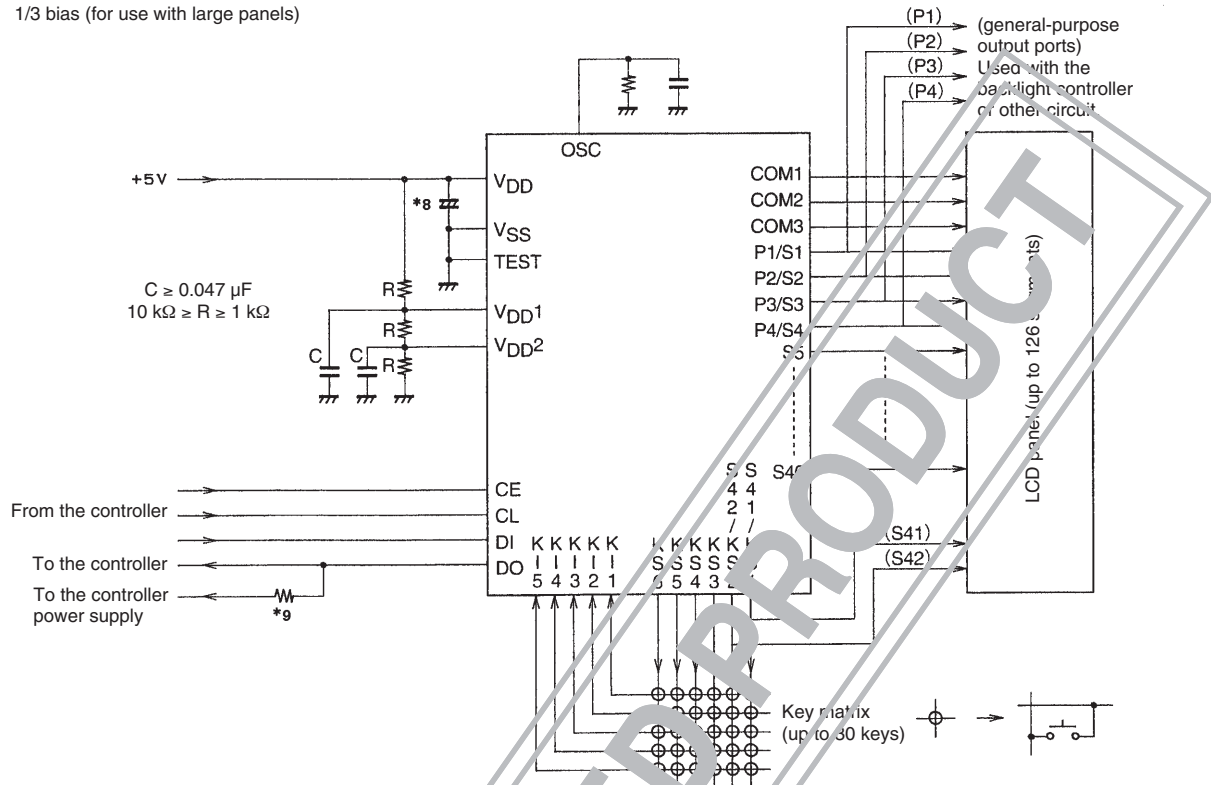

- Note: \*8. Add a capacitor to the power supply line so that the power supply voltage  $V_{DD}$  rise time when power is applied and the power supply voltage  $V_{DD}$  fall time when power drops are both at least 1 ms, as the LC75853NE/NW is reset by the VDET.
- \*9. The DO pin, being an open-drain output, requires a pull-up resistor. Select a resistance (between 1 to 10 k $\Omega$ ) appropriate for the capacitance of the external wiring so that signal waveforms are not degraded.

Notes on transferring display data from the controller

The display data (D1 to D126) is transferred to the LC75853NE/NW in three operations. All of the display data should be transferred within 30 ms to maintain the quality of the displayed image.

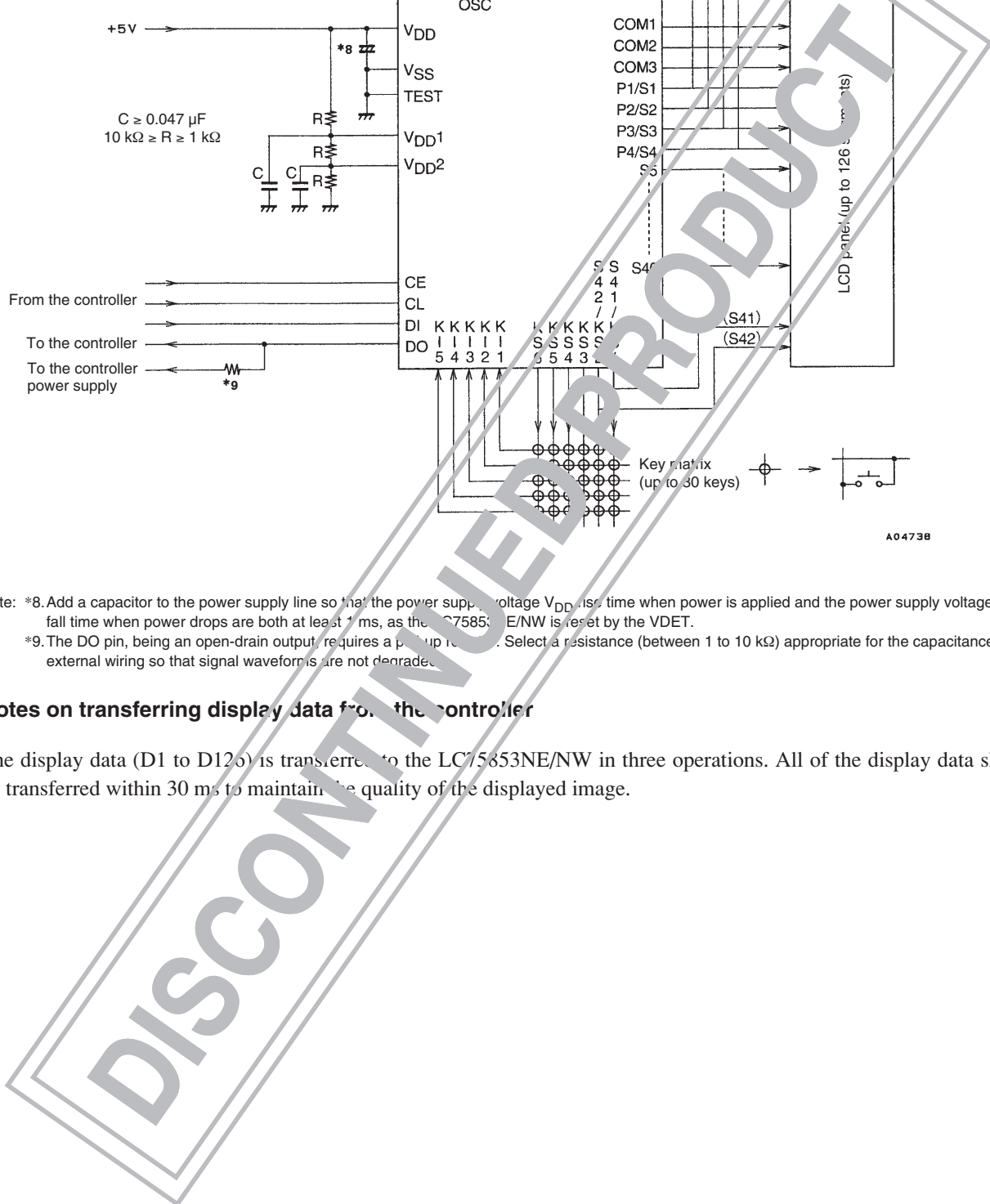

Notes on the controller key data read techniques

1. Timer based key data acquisition

- Flowchart

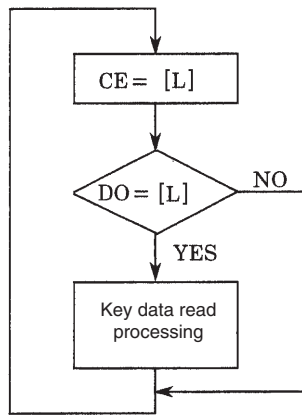

- Timing chart

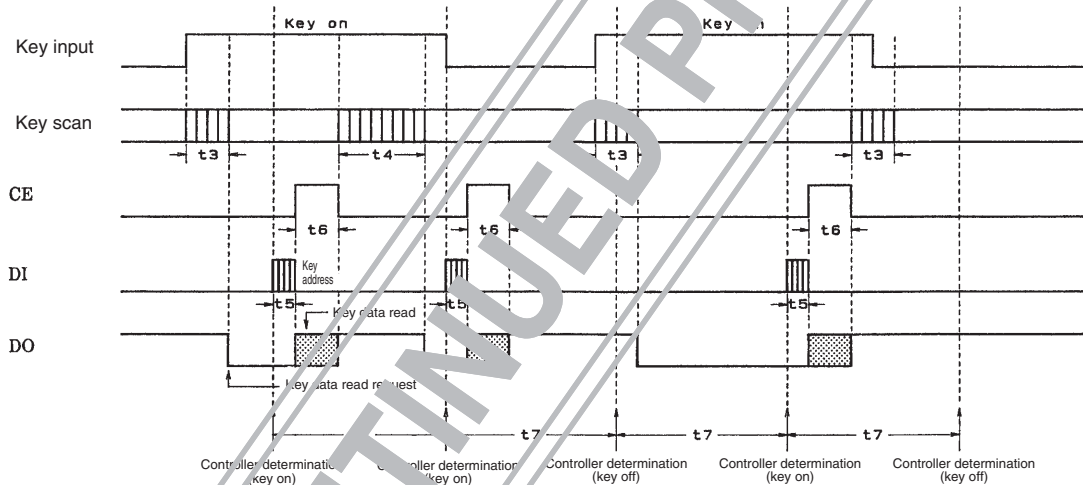

A03063

t3: Key scan execution time when the key data agreed for two key scans. (615 T (s))

t4: Key scan execution time when the key data did not agree for two key scans and the key scan was executed again. (1230 T (s))

$$T = \frac{1}{f_{OSC}}$$

t5: Key address (43H) transfer time

t6: Key data read time

- Explanation

In this technique, the controller uses a timer to determine key on/off states and read the key data. The controller must check the DO state when CE is low every t7 period without fail. If DO is low, the controller recognizes that a key has been pressed and executes the key data read operation.

The period of this technique must satisfy the following condition.

$$t7 > (t5 + t6 + t4)$$

If a key data read operation is executed when DO is high, the read key data (KD1 to KD30) and sleep acknowledge data (SA) will be invalid.

2. Interrupt based key data acquisition

- Flowchart

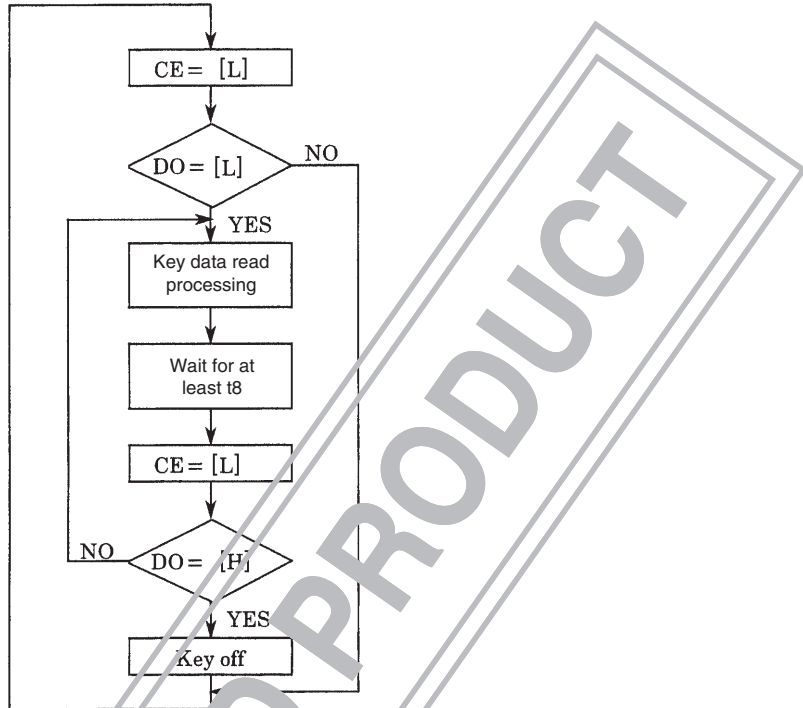

- Timing chart

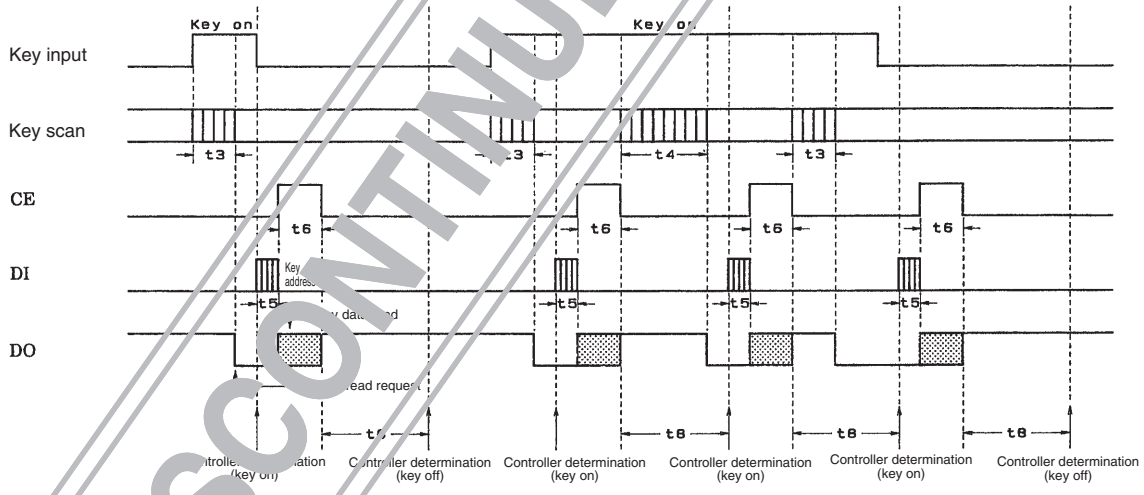

A03064

t3: Key scan execution time when the key data agreed for two key scans. (615 T (s))

t4: Key scan execution time when the key data did not agree for two key scans and the key scan was executed again. (1230 T (s))

$$T = \frac{1}{f_{osc}}$$

t5: Key address (DI) transfer time

t6: Key data read time

- Explanation

In this technique, the controller uses interrupts to determine key on/off states and read the key data. The controller must check the DO state when CE is low. If DO is low, the controller recognizes that a key has been pressed and executes the key data read operation. After that the next key on/off determination is performed after the time  $t_8$  has elapsed by checking the DO state when CE is low and reading the key data. The period  $t_8$  in this technique must satisfy the following condition.

$$t_8 > t_4$$

If a key data read operation is executed when DO is high, the read key data (KD1 to KD5) and sleep acknowledge data (SA) will be invalid.

- Specifications of any and all SANYO products described or contained herein stipulate the performance, characteristics, and functions of the described products in the independent state, and are not guarantees of the performance, characteristics, and functions of the described products as mounted in the customer's products or equipment. To verify symptoms and states that cannot be evaluated in an independent device, the customer should always operate and test devices mounted in the customer's products or equipment.
- SANYO Electric Co., Ltd. strives to supply high-quality high-reliability products. However, any and all semiconductor products fail with some probability. It is possible that these probabilistic failures could give rise to accidents or events that could endanger human lives, that could give rise to smoke or fire, or that could cause damage to other property. When designing equipment, adopt safety measures so that these kinds of accidents or events cannot occur. Such measures include but are not limited to protective circuits and error prevention circuits for safe design, redundant design, and structural design.
- In the event that any or all SANYO products (including technical data, services) described or contained herein are controlled under any of applicable local export control laws and regulations, such products must not be exported without obtaining the export license from the authorities concerned in accordance with the applicable law.
- No part of this publication may be reproduced or transmitted in any form or by any means, electronic or mechanical, including photocopying and recording, or any information storage or retrieval system, or otherwise, without the prior written permission of SANYO Electric Co., Ltd.
- Any and all information described or contained herein are subject to change without notice due to product/technology improvement, etc. When designing equipment, refer to the "Delivery Specification" for the SANYO product that you intend to use.
- Information (including circuit diagrams and circuit parameters) herein is for example only; it is not guaranteed for volume production. SANYO believes information herein is accurate and reliable, but no guarantees are made or implied regarding its use or any infringements of intellectual property rights or other rights of third parties.

This catalog provides information as of October, 1999. Specifications and information herein are subject to change without notice.